

Schlauchschellen mit Schneckenantrieb Form A DIN 3017

Schlauchschellen
Edelstahl A4 / W5

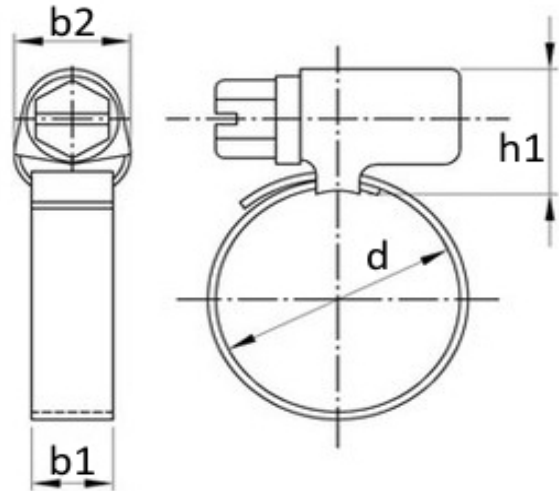

d	b1	b2	h1					
10-16	9	14	14					
12-22	9	14	14					
16-27	9	14	14					
20-32	9	14	14					
25-40	9	14	14					
30-45	9	14	14					
35-50	9	14	14					
40-60	9	14	14					
50-70	9	14	14					
12-22	12	20	16					
16-27	12	20	16					
20-32	12	20	16					
25-40	12	20	16					
30-45	12	20	16					
35-50	12	20	16					
40-60	12	20	16					
50-70	12	20	16					
60-80	12	20	16					
70-90	12	20	16					
80-100	12	20	16					
90-110	12	20	16					
100-120	12	20	16					
110-130	12	20	16					

Maße in mm